



TIME CRISIS II



namco

WARNING: READ BEFORE USING YOUR PLAYSTATION®2 COMPUTER ENTERTAINMENT SYSTEM.

A very small percentage of individuals may experience epileptic seizures when exposed to certain light patterns or flashing lights. Exposure to certain patterns or backgrounds on a television screen or while playing video games, including games played on the PlayStation 2 console, may induce an epileptic seizure in these individuals. Certain conditions may induce previously undetected epileptic symptoms even in persons who have no history of prior seizures or epilepsy. If you, or anyone in your family, has an epileptic condition, consult your physician prior to playing. If you experience any of the following symptoms while playing a video game – dizziness, altered vision, eye or muscle twitches, loss of awareness, disorientation, any involuntary movement, or convulsions – IMMEDIATELY discontinue use and consult your physician before resuming play.

WARNING TO OWNERS OF PROJECTION TELEVISIONS:

Do not connect your PlayStation 2 console to a projection TV without first consulting the user manual for your projection TV, unless it is of the LCD type. Otherwise, it may permanently damage your TV screen.

USE OF UNAUTHORIZED PRODUCT:

The use of software or peripherals not authorized by Sony Computer Entertainment America may damage your console and/or invalidate your warranty. Only official or licensed peripherals should be used in the controller ports or memory card slots.

HANDLING YOUR PLAYSTATION 2 FORMAT DISC:

- This disc is intended for use only with PlayStation 2 consoles with the NTSC U/C designation.
- Do not bend it, crush it or submerge it in liquids.
- Do not leave it in direct sunlight or near a radiator or other source of heat.
- Be sure to take an occasional rest break during extended play.
- Keep this compact disc clean. Always hold the disc by the edges and keep it in its protective case when not in use. Clean the disc with a lint-free, soft, dry cloth, wiping in straight lines from center to outer edge. Never use solvents or abrasive cleaners.

TABLE OF CONTENTS

PlayStation®2 Setup	2
Controller Operations	3
DUALSHOCK™2 and DUALSHOCK™	
analog controller configuration	
GUNCON™ and GUNCON™2 Operations	4
Controls	
Using the Controller to Reload	
Resetting the Game	
How to Connect your Guncon	
How to Connect your Guncon2	
Using Guncon and Guncon2 together	
Introduction	9
Starting the Game	10
How to Calibrate the Guncon	
Memory Card (8MB) (for PlayStation®2)	
Main Menu	
Arcade	
Extra Games	
Database	
Options	
How to Play	12
Game Screen	
Rules of the Game	
Arcade	14
One Player	
Two Player	
Double Gun	
Link	
Rankings	
Game Options	
Extra Games	16
Agent Trainer	
Quick&Crash	
Shoot Away 2	
Database	17
Arcade	
Extra Games	
Options	18
Controller	
Screen	
Sound	
Game Data	
Characters	20
Hints	22
Credits	23

PLAYSTATION®2

SETUP

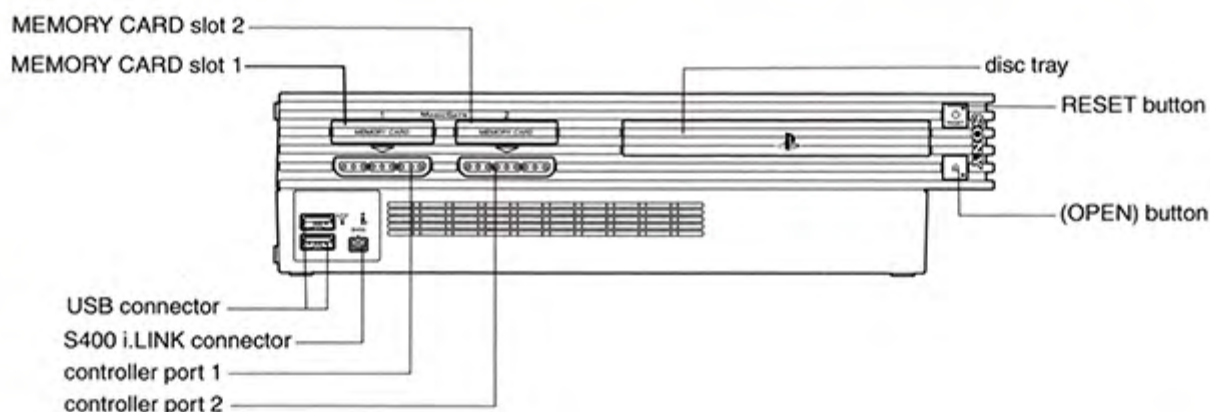

Set up your PlayStation®2 computer entertainment system according to the instructions in its Instruction Manual. Make sure the MAIN POWER switch (located on the back of the console) is turned on. Press the RESET button. When the power indicator lights up, press the open button and the disc tray will open. Place the *TIME CRISIS*®2 disc on the disc tray with the label side facing up. Press the open button again and the disc tray will close. Attach game controllers and other peripherals, as appropriate. Follow on-screen instructions and refer to this manual for information on using the software.



CONTROLLER OPERATIONS

DUALSHOCK™2 ANALOG CONTROLLER CONFIGURATIONS

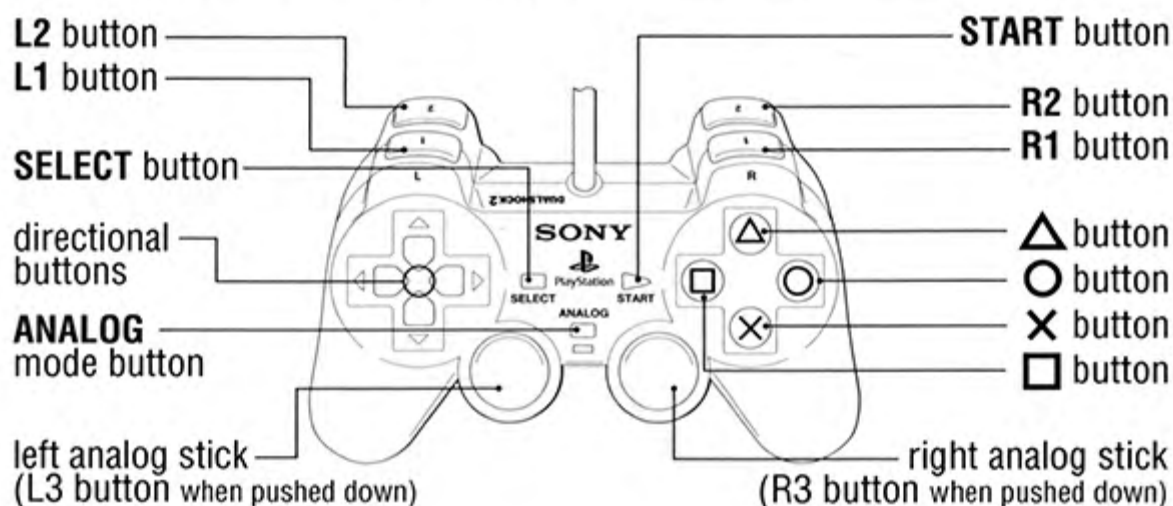

CONTROLS

	MENU CONTROLS	GAMEPLAY CONTROLS
Directional buttons ← → ↑ ↓	Select menu options	Aim the cursor
Left analog stick	N/A	Aim the cursor
R2 button (Hold)	N/A	Change cursor speed
L2 button (Hold)	N/A	Change cursor speed
START button	N/A	Pause the game
○ button	N/A	Shoot
× button	Confirm menu selection	Shoot
Δ button	Cancel menu selection	Shoot
□ button	N/A	Shoot
R1 button	Simple menu selection	Reload
L1 button	Simple menu selection	Reload

*To use the left analog stick, press the ANALOG mode button.

RELOAD

Release the RELOAD button to evade enemy fire and reload your gun. Remember, you cannot shoot from this position.

To shoot and attack the enemy, press the RELOAD button. RELOAD method can be changed in Options. (See Pg. 18)



RELOAD position

STANDARD CONTROLLER

The controls for the standard controller are the same as the DUALSHOCK™2 / DUALSHOCK™ analog controller, with the exception of the left analog stick.

RESETTING THE GAME

In some screens, the game can be soft reset by simultaneously pressing the L1, L2, R1, R2 SELECT and START buttons.

GUNCON™ & GUNCON™ 2 OPERATIONS

When playing with a Guncon or a Guncon2 controller, be sure to calibrate it on the Guncon Calibration Screen that appears at the beginning of the game. The Guncon's aim may not be accurate if you play without first calibrating. For instructions, see "How to Calibrate the Guncon" on Pg. 10.

GUNCON

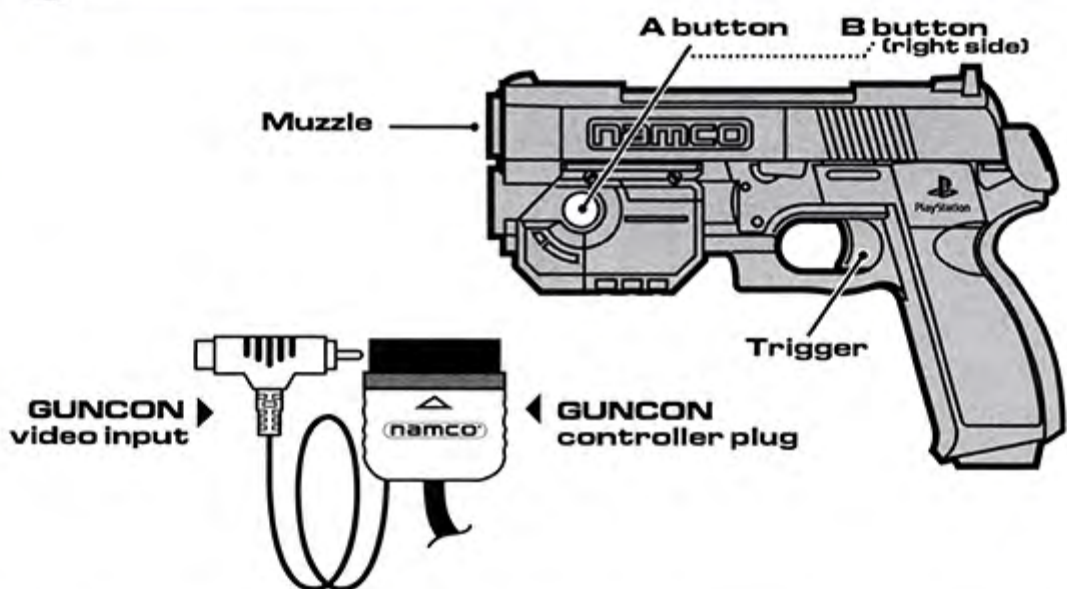

GUNCON 2

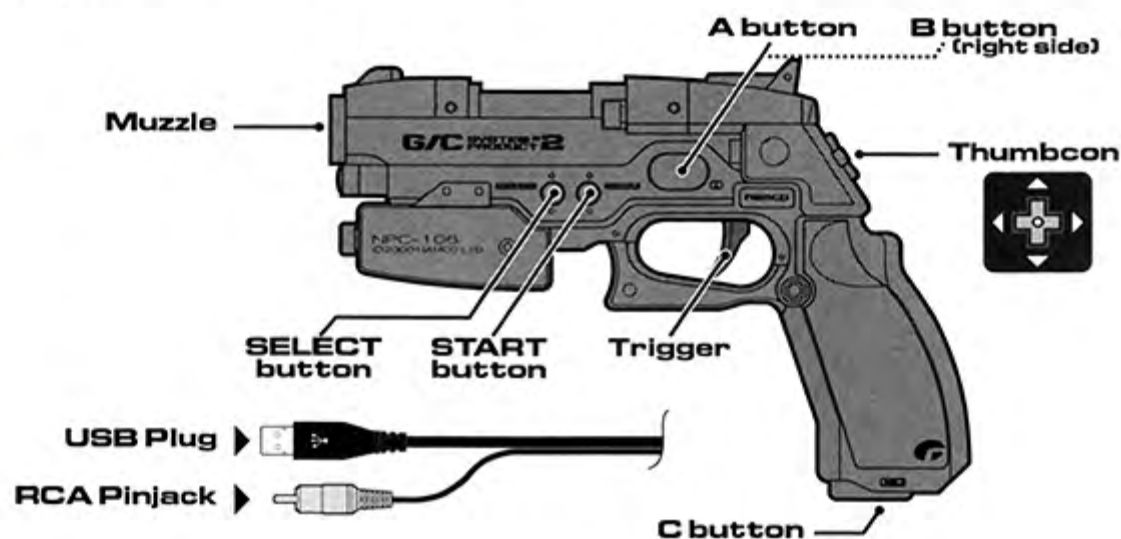



CONTROLS

This section explains how to use the controllers to play the game.



GUNCON2



Guncon

	MENU CONTROLS	GAMEPLAY CONTROLS
Trigger	Confirm menu selection	Shoot
Aim the controller	Select a menu option	Aim
Thumbcon (Guncon2 only)	Select a menu option	Reload
A button	N/A	Reload
B button (Guncon only)	N/A	Pause the game
B button (Guncon2 only)	N/A	Reload
C button (Guncon2 only)	N/A	Reload
START button (Guncon2 only)	N/A	Pause the game

*To select Menu options using the Thumbcon, aim the Guncon2 away from the screen and then press the Thumbcon to select.



USING THE CONTROLLER TO RELOAD

If the Guncon2 is connected to the top USB connector and a controller is connected to controller port 1, Player 1 can press any of the buttons on the controller to RELOAD. The same applies to Player 2 using the bottom USB connector and controller port 2.



RESETTING THE GAME

The game can be soft reset by pulling the Trigger and pressing the START button (B button for Guncon) while the game is paused.

HOW TO CONNECT YOUR GUNCON

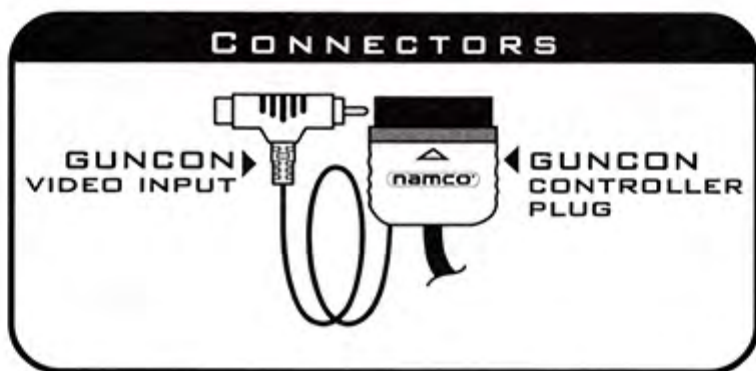
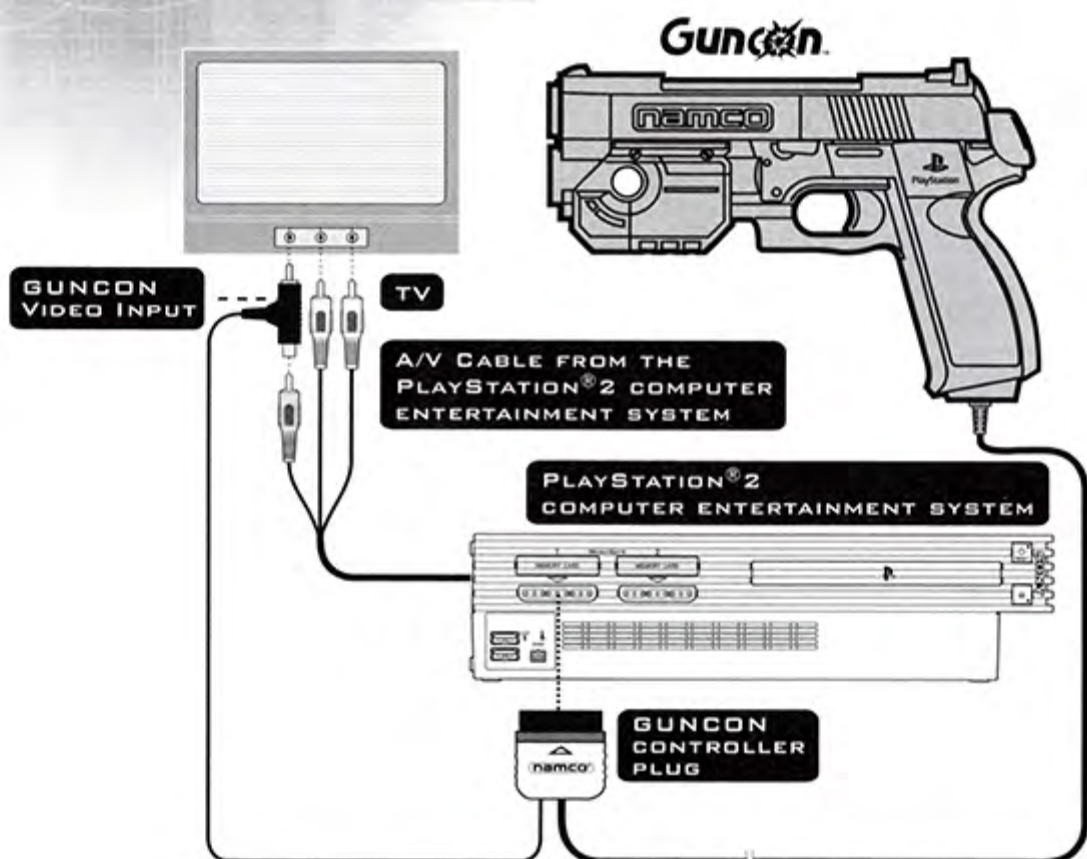

- Connect the Guncon controller plug into controller port 1. Connect the A/V cable from the PlayStation®2 computer entertainment system to the female side of the Guncon video input. Plug these connected cables into your television set.
- When connecting two Guncon controllers, you must first plug the Guncon video input cables into each other, connect the A/V cable and then plug these connected cables into your television set. Finally, connect the Guncon controllers into controller ports 1 and 2.



HOW TO CONNECT YOUR GUNCON2

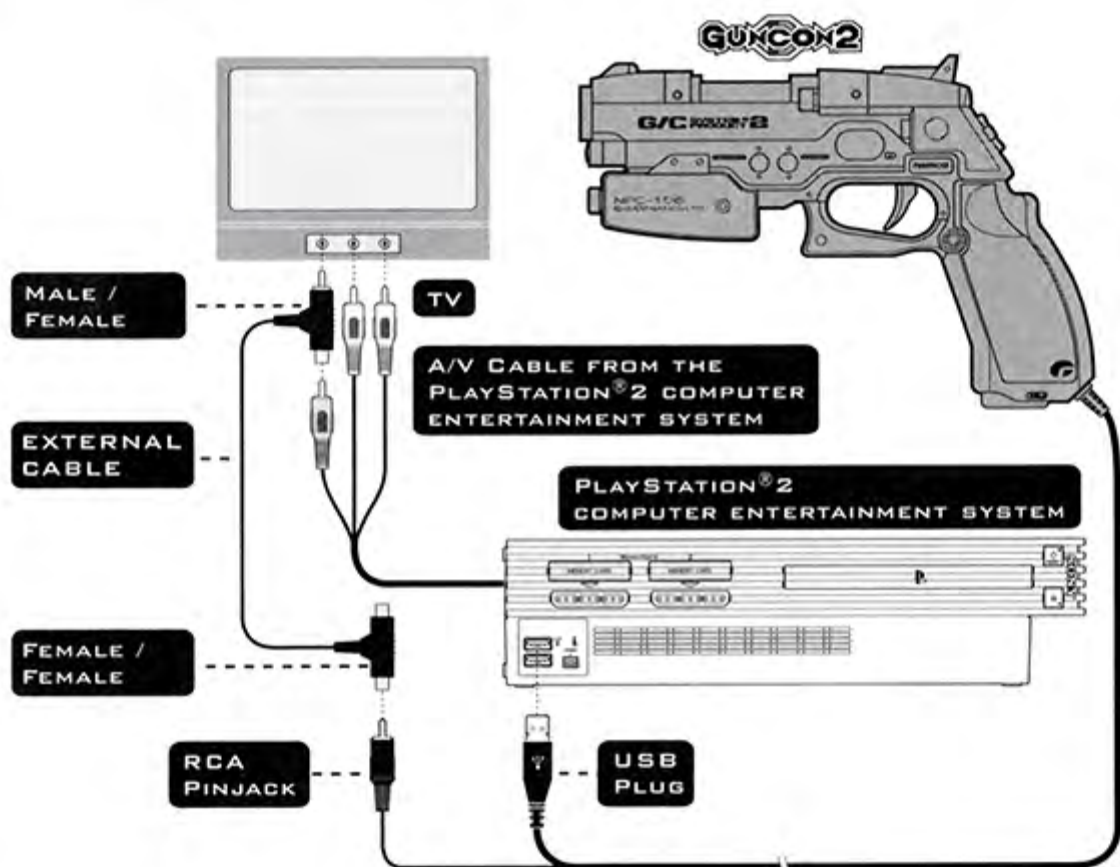

- Connect the A/V cable from the PlayStation®2 computer entertainment system to the male/female portion of the External Cable. Plug this portion of the External Cable into your television set. Connect the RCA pinjack from the Guncon2 into the remaining portion of the External Cable. For two guns, connect the 2nd gun to the remaining free side of the External Cable.

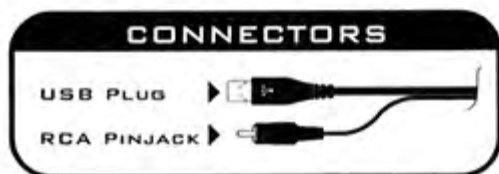

- Connect the USB plug into the top USB connector located on the front of the PlayStation®2 computer entertainment system. To play with two guns, insert the USB plug for Player 2's gun into the bottom USB connector.

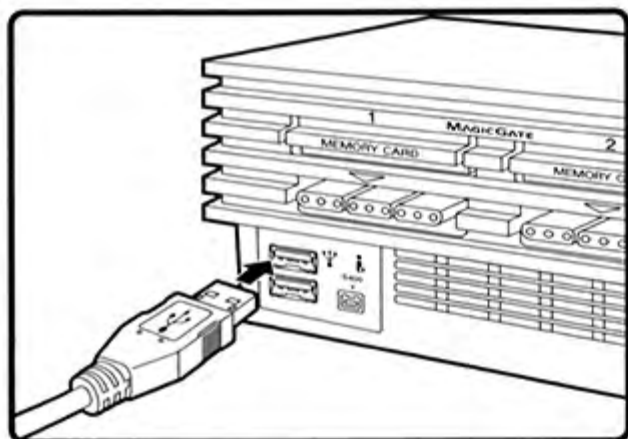

USING GUNCON & GUNCON2 TOGETHER

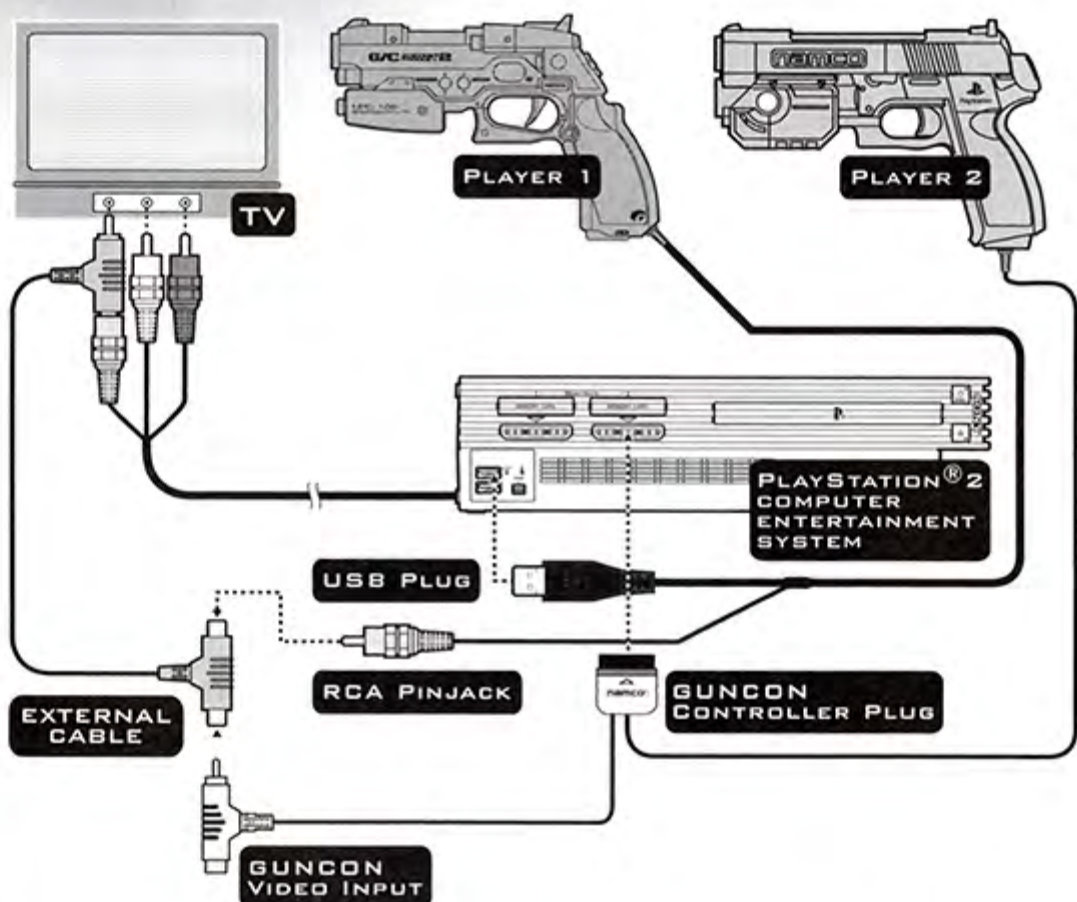

- Plug the Video Input from the Guncon into one end of the female/female portion of the External Cable supplied with the Guncon2. Next, connect the RCA pinjack from the Guncon2 into the remaining free side of the External Cable. Connect the A/V Cable from the PlayStation 2 into the male/female portion of the External Cable. Plug this portion of the External Cable into your television set.
- Connect the USB plug from the Guncon2 into the top USB connector located on the front of the PlayStation 2 console. Connect the controller plug from the Guncon into controller port 2. You are now ready to play using both guns!
- When using the Guncon and Guncon2 together, make sure the controllers are not connected to the controller port and USB connector of the same player. For example, if a Guncon2 is connected to the top USB connector and a Guncon to controller port 1, the Guncon2 connected to the top USB connector will override the Guncon in controller port 1. (The same is true for the bottom USB connector and controller port 2.)

INTRODUCTION



As a business leading the way for the next-generation communication system, Neodyne Industries Ltd. inaugurated their plans for the "Starline Network". With 64 low-orbit communication satellites already developed, Neodyne announced their plans for the launch of the satellites in the coming month.

However, 3 weeks before the planned launch of the satellites, the international special intelligence group, VSSE uncovered the shocking truth. Their intelligence learned that some of the satellites scheduled for the launch are actually strategic military satellites. To collect more evidence about their intent, VSSE immediately dispatched Christy Ryan to penetrate Neodyne as an undercover agent. Although Christy successfully gathered information about Neodyne's intent, her identity was uncovered and she has become a fugitive within the Neodyne compound.

To rescue Christy and retrieve the information, VSSE called for their best, Secret Agents Keith Martin and Robert Baxter, to infiltrate the Neodyne compound.

STARTING THE GAME



HOW TO CALIBRATE THE GUNCON

Before you start playing, you need to calibrate the Guncon. If you have the Guncon controller connected to the console, the Guncon Calibration screen will automatically appear when you start up the game. You can also access the Guncon Calibration screen by selecting GUNCON CALIBRATION in OPTIONS mode. (See Pg. 18)

In the Guncon Calibration screen, aim the Guncon at the "+" mark at the center of the screen and pull the Trigger. Pull the Trigger as many times as it takes to adjust your aim. When you are done adjusting your aim, press the A or B button to proceed to the next screen. The aim may be off if you start playing without calibrating the Guncon.

If you are using the Guncon2, you can do a 2-Point Adjustment for better calibration. To perform the 2-Point Adjustment, aim the Guncon2 away from the screen and press the Trigger + C button. If you are using a progressive-scan TV, the Guncon2 will automatically perform the 2-Point Adjustment.



- Guncon/Guncon2 does not support hi-vision, LCD, plasma display or projection TVs. Some progressive-scan, multiple-function and hi-level TVs also may not be supported.
- TV type (standard/progressive) is determined only with the Guncon2. If the Guncon2 controllers are connected to both USB connectors, the TV type will be determined by Player 1. If Player 1 is using the Guncon and Player 2 is using the Guncon2, the TV type will be determined by Player 2.
- When using progressive-scan TV, there is a high chance that you will not be able to adjust the Guncon on the Player 1 side. If progressive-scan TV is selected using Guncon2 on the Player 1 side, Guncon on the Player 2 side will not operate.
- Manual 2-point adjustment is only available with the Guncon2. However, if manual 2-point adjustment is performed with the Guncon2 on the Player 1 side, the setting can be reflected in the Guncon on the Player 2 side.
- 2-point adjustment is not necessary with a standard TV. (It is designed for use with a wide-screen TV.)



MEMORY CARD (BMB) (FOR PLAYSTATION®2)

Insert a memory card into MEMORY CARD slot 1 to load a saved game or create a new **Time Crisis 2** game file.

The game will automatically check for a memory card in MEMORY CARD slot 1 when you start up the game. If a memory card is present in MEMORY CARD slot 1, the saved game data will automatically be loaded. If no saved game data is present in the memory card, you will be asked if you want to create a new game data file. Select YES to create a new game file on the memory card. Select NO to proceed to the Main Menu without creating a new game file. If you selected YES, you are given an option to turn on the AUTO SAVE feature. Select YES again to automatically save rankings and game settings. AUTO SAVE can also be turned ON/OFF in Options. (See Pg. 19)



MAIN MENU

To display the Main Menu, press any button at the Title screen. Various game options can be selected from this screen. To select an option from the Main Menu, aim the Guncon to the option you want to select and then pull the Trigger.



ARCADE



Play the original **Time Crisis 2** arcade game. (1 or 2 Players.)



EXTRA GAMES



Play various mini-games to polish your aiming skills. Some games are hidden and can only be played by performing certain requirements to unlock them.



OPTIONS



Adjust various game settings, including the number of lives, game difficulty level, controller, game data, screen and sound setting.



DATABASE



Check out the score rankings of your previous plays in different game modes.

HOW TO PLAY



GAME SCREEN

SCORE



CURSOR

BULLETS

TIME LIMIT

LIFE

SCORE

Your score and number of Combo Hits.

CURSOR

The cursor is where you are aiming when using a controller. The red cursor is Player 1. The blue cursor is Player 2. The cursor is not displayed on-screen when using the Guncon or Guncon2 to play.

BULLETS

The number of bullets left. To replenish your ammo, use RELOAD.

LIFE

You lose 1 life for every time you are shot, hit by an object, or when the time limit reaches 0.

TIME LIMIT

There is a 40 second time limit for each of the Action Points. You will lose 1 life if the time limit reaches 0.



RULES OF THE GAME

Below are explanations of rules for the Arcade mode. For the explanation of the game rules for Extra Games, see Pg. 16.



ACTION POINT

The game will proceed forward as each Action Point is cleared. Defeat all the enemies to clear an Action Point. Once an Action Point is cleared, -WAIT- is displayed on-screen while you move on to the next Action Point. When you reach the next Action Point, -ACTION!- is displayed on-screen and the action will resume.



TIME LIMIT

There is a 40 second time limit for each of the Action Points. You will lose 1 life if the time limit reaches 0.



CONTINUE

The Continue screen appears if you have Credits left but no Lives left in the current game. You can continue a game as long as you still have Credits remaining. To continue a game, shoot "YES" displayed on-screen. Shoot "NO" to quit the game and return to the Title screen.



GAME OVER

The Game Over screen appears if you select "NO" in the Continue screen, or if you have no Credits or Lives left. If AUTO SAVE is "ON", your ranking data and hidden features that are unlocked are automatically saved.



TIME CRISIS 2 ARCADE

This section explains how to play the original arcade hit **Time Crisis 2**. Select **STORY MODE** to play all three stages in order, or select **ONE STAGE TRIAL** to play one stage only.



ONE PLAYER

Play the One Player Arcade mode. See Pg. 13 for the "Rules of the Game".



TWO PLAYER

Play the Two Player cooperative Arcade mode in split-screen. The rules of the game are exactly the same as the One Player game, but the same Credits are shared by Player 1 and Player 2.



DOUBLE GUN

Play the One Player Arcade mode using two guns. The game rules are basically the same as the One Player Arcade mode, but there is an additional display for the number of bullets left in the second gun at the bottom-right corner of the screen.



RELOADING IN DOUBLE GUN MODE

If the buttons are set to default, the RELOAD buttons for both Guncon controllers must be pressed to attack. To attack pressing only one of the RELOAD buttons, set the RELOAD method of the Guncon controller that will not be used to RELOAD to "Hold to RELOAD". (See Pg. 18 "OPTIONS: Controller" for more details.)

LINK

Use the i.LINK cable (sold separately) to connect two PlayStation2 computer entertainment systems and two TVs together to play in Two Player Link mode.

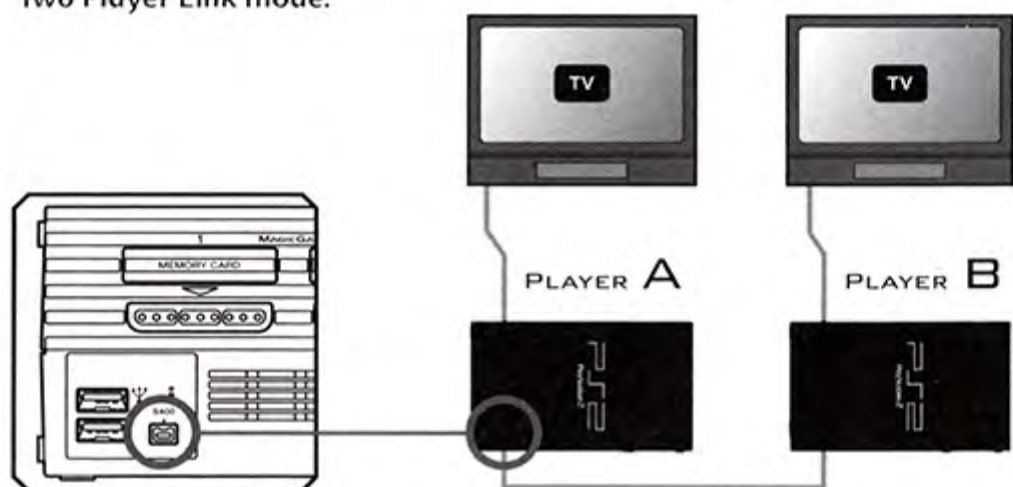

To play the Link mode, you must have two PlayStation2 computer entertainment systems, two TVs, two **Time Crisis 2** CD-ROMs and one i.LINK cable (4-pin S400 compatible cable).

To set the correct player positions, **PLAYER A** must select **LEFT** in the Selection screen or be the first to make the link entry. Game difficulty and number of lives are set by **PLAYER A**.

NOTE

The Guncon and Guncon2 are not compatible with the 2-screen display function available in certain TVs (Picture in Picture). Do not connect or disconnect the i.LINK cable while the power on the console is ON. Always connect the i.LINK cable directly from console to console. Do not connect it to a hub or extension cable. Always use i.LINK cables that are compatible with S400.

RANKINGS

View the score rankings for the Arcade mode. See "DATABASE: Arcade" on Pg. 11 for more details.

GAME OPTIONS

Change the game difficulty level and number of lives.

4 CRISIS EXTRA GAMES

There are various game modes that can be selected in Extra Games. Select a game to play and test your shooting skills or compete against a friend. For game rules, read the on-screen rules and instructions displayed at the selection of each game mode.

AGENT TRAINER

Play and compete for shooting accuracy at the shooting range. There are 4 different difficulty levels to choose from. The player with the highest score total after 2 rounds wins.



QUICK & CRASH

Play the original arcade hit where you compete in the game of quick-draw. Point the Guncon away from the screen. When targets appear, aim and shoot the targets. The goal is to shoot all the targets as fast as you can with limited number of ammo allotted.



SHOOT AWAY 2

Play the classic arcade hit where you compete in the game of skeet shooting. Aim and shoot the clays before they disappear into the horizon.



5 CRISIS 3 DATABASE

Select this option to check out the score rankings for Arcade and Extra Games. To scroll to the next page, press the A or B button on the Guncon.

ARCADE

Select ARCADE to view the Top 20 score rankings for the various modes in Arcade. NORMAL is the score rankings for standard play, and SPECIAL is the score rankings for play using the hidden features.

rank	name	score	time
1st	RHD	60000	23'59"99
2nd	KIH	55000	21'59"99
3rd	SHD	50000	23'59"99
4th	CRS	45000	23'59"99
5th	DIZ	40000	23'59"99

EXTRA GAMES

Select one of the games to view the Top 5 score rankings of the respective games.

rank	name	score	OK
1	EBS	88	OK
2	SBY	86	OK
3	HJK	84	OK
4	YYG	82	OK
5	SJK	80	OK



6 OPTIONS

Select **OPTIONS** to adjust various game settings. To select an option, aim with the Guncon and pull the Trigger. If you are using any other controller, press the directional buttons to select and press the X button to confirm the selection.

GAME OPTIONS

Select this option to adjust the number of lives and the game difficulty level of the Arcade mode. To adjust the setting, aim at the setting you want to adjust and shoot.



CONTROLLER

Select this option to assign the **RELOAD** button, and change the **RELOAD** method. You can **RELOAD** by aiming away from the screen and pulling the Trigger if the **OFF SCREEN** method is selected. If you are using a controller, you can also use this option to adjust the cursor speed.



SCREEN

Select **ADJUST SCREEN** to adjust the position of the screen. To adjust the screen, aim and shoot the arrow indicating the direction that you want the screen to shift.

Select **BRIGHTNESS** to display the screen that allows you to adjust the TV brightness. To return to the Options screen, press the A or B button on the Guncon.





SOUND

Select this option to adjust the BGM and SE volume or set STEREO / MONO. To adjust settings, aim and shoot the arrows of the setting that you want to adjust.



GAME DATA

Select this option to Save/Load game data and toggle ON/OFF AUTO SAVE. To select an option or change settings, aim and shoot the icon that you want to adjust. Only one **Time Crisis 2** game data file can be saved on a memory card. Remember, your game data will not be saved automatically even if AUTO SAVE is ON if a new game data file has not been created already.



CHARACTERS



KEITH MARTIN



BIRTHPLACE: GREAT BRITAIN
 AGE: 27
 CODE NAME: CHERUB
 DESCRIPTION:

One of the heroes of the game. Former agent of SAS specializing in explosives. On paper, Keith is a Hollywood special-effects technician, but in reality he is an elite VSSE agent.

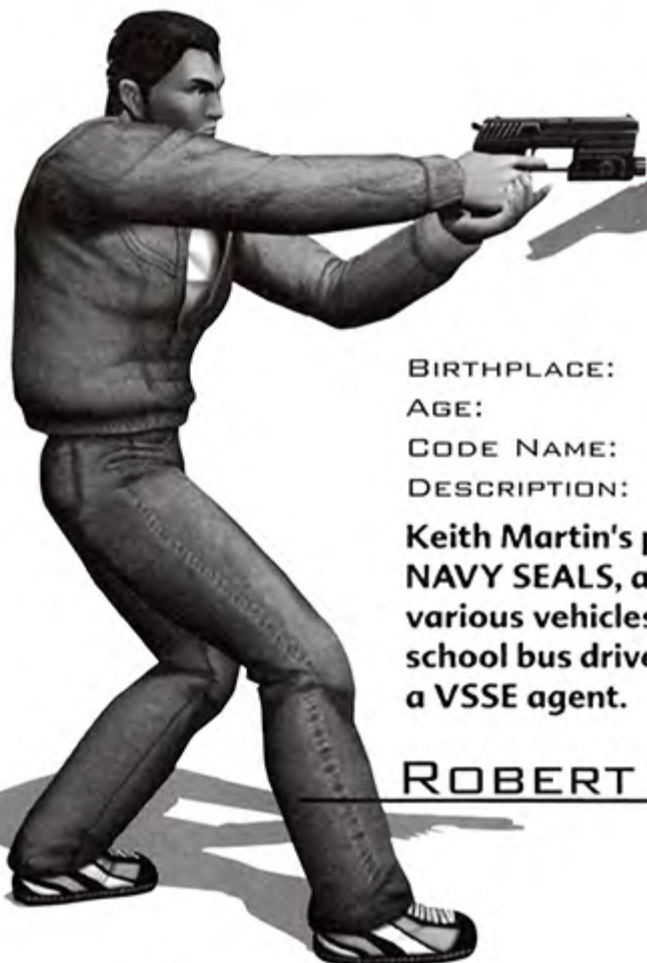

BIRTHPLACE: USA
 AGE: 29
 CODE NAME: GRIFFON
 DESCRIPTION:

Keith Martin's partner. Former member of the NAVY SEALS, and an expert pilot/driver of various vehicles. On paper, Robert is a school bus driver. In reality, he is a VSSE agent.

ROBERT BAXTER



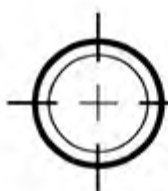

CHRISTY RYAN

BIRTHPLACE: USA

AGE: 24

DESCRIPTION:

A VSSE special agent. A super-intellectual who graduated from Harvard at the young age of 17. As an undercover agent, Christy penetrated NDI security posing as Diaz's secretary, but she was captured when her true identity was uncovered.



WILD DOG



DESCRIPTION:

A wanted criminal. The former leader of a mercenary group. In his encounter with "Richard", a secret agent of VSSE, he lost his arm and was left with a scarred face. His arm has since been reconstructed and replaced with a mechanical weapon.



ERNESTO DIAZ

DESCRIPTION:

The head of NDI. A retired officer who has been committing crimes in the underworld since his tenure as an officer. With intent to conquer the world, he concocted a secret plan to launch military satellites into orbit.



TIME CRISIS 3 8 HINTS



SCORING

You can earn the most points by aiming for the enemy's head. The normal enemies can also be shot multiple times for a total of 3 scoring hits. Combo Hit Bonus can be earned by quickly hitting the enemies multiple times. No-Miss Bonus can be earned by consecutively hitting the enemies without missing. You can also earn additional bonus points by quickly completing an area.



HIDDEN FEATURES

There are hidden features in the game that can be unlocked by fulfilling certain requirements. You can check the requirements for unlocking a hidden feature by selecting an option that has yet to be unlocked.





9

CREDITS

Published by:

Developed and Designed by:

Namco Hometek Inc.

Namco Limited

Project Supervisor:

Yas Noguchi

Producer:

Aki Kozu

Senior Marketing Manager:

Stacey Sujishi

Assistant Product Manager:

Yoshi Niki

Public Relations Manager:

Hugo Reyes

Quality Assurance Manager:

Brian Schorr

Product Coordinator:

James Guirao

Lead Analyst:

Mike Peterson

Testers:

Ryan Chennault

Adrian Escultura

Daryle Tumacder

Jesse Mejia

Manual Design:

INO Communications, Inc.

Special Thanks:

Yoshi Homma

Jesse Taylor

Berry Kane

Garry Cole

Robert Ennis

Jennifer Tersigni

Jon Kromrey

Nao Higo

Takashi Eblike

TIME CRISIS II

10 NOTES

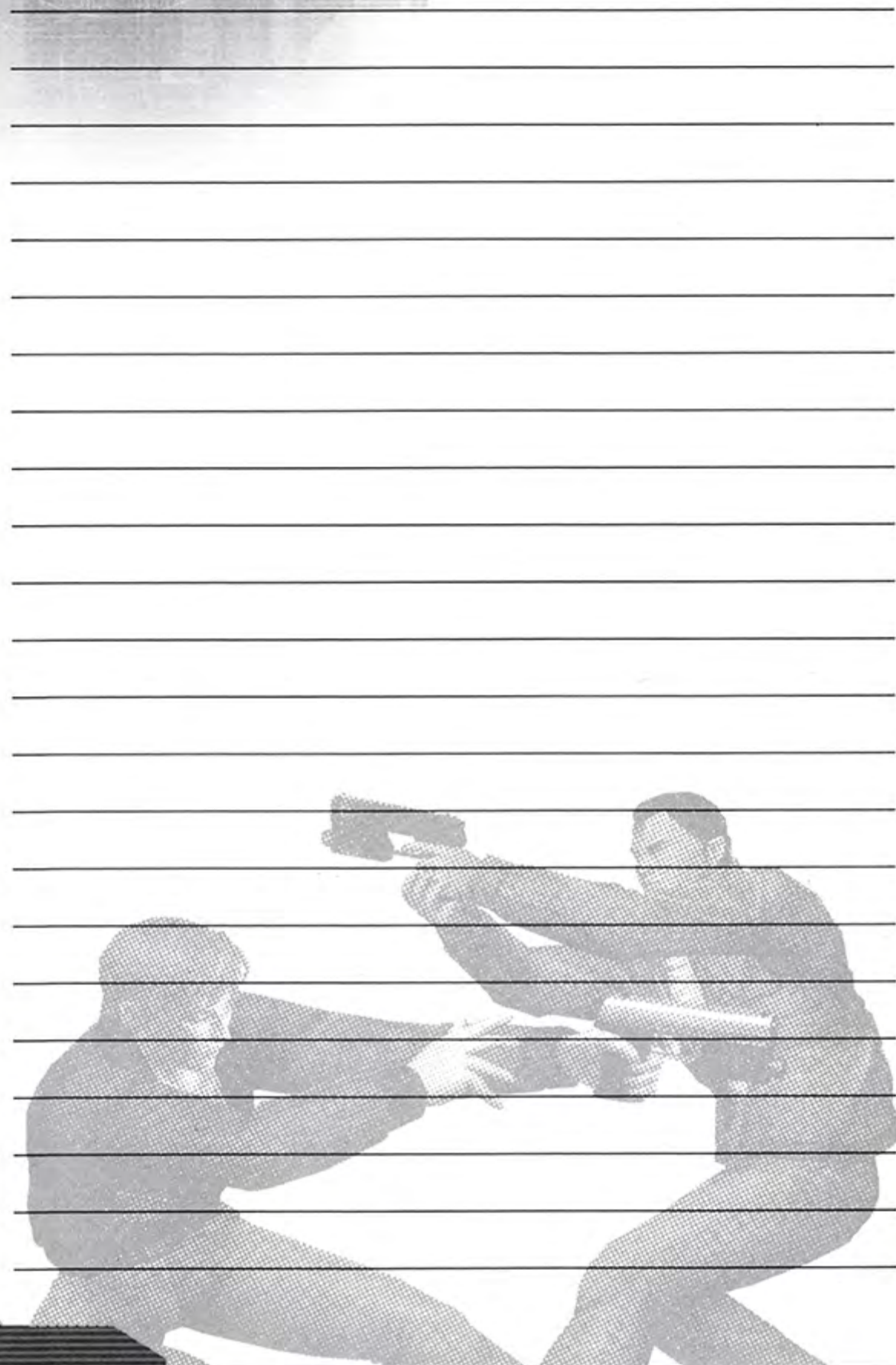

Namco Tip Line: 1-900-737-2262

\$.95/minute for automated tips. \$1.15/minute for live counseling.

9am-5pm Monday-Friday Pacific Time.

Under 18, please have your parent's permission. Touchtone phones only.

For questions and information not listed on the 900 line, write to:

**NAMCO HOMETEK INC.
ATTN: CUSTOMER SERVICE
2055 JUNCTION AVENUE
SAN JOSE, CA 95131**

Namco Online: <http://www.namco.com>

Visit our Website to get information about our new titles.

LIMITED WARRANTY

Namco Hometek Inc. warrants to the original purchaser that this Namco Hometek Inc. game pak shall be free from defects in material and workmanship for a period of ninety (90) days from the date of purchase. If a defect covered by this limited warranty occurs during this 90-day limited warranty period, Namco Hometek Inc. will repair or replace the defective game pak or component part, at its option, free of charge.

This limited warranty does not apply if the defects have been caused by negligence, accident, unreasonable use, modification, tampering, or any other cause not related to defective material or workmanship.

LIMITATIONS ON WARRANTY

Any applicable implied warranties of merchantability and fitness for a particular purpose, are hereby limited to ninety (90) days from the date of purchase and are subject to the conditions set forth herein. In no event shall Namco Hometek Inc. be liable for consequential or incidental damages resulting from the possession or use of this product.

The provisions of the limited warranty are valid in the United States only. Some states do not allow limitations on how long an implied warranty lasts, or exclusion of consequential or incidental damages, so the above limitation or exclusion may not apply to you. This limited warranty provides you with specific legal rights. You may have other rights which vary from state to state.



Namco Hometek Inc., 2055 Junction Avenue, San Jose, CA 95131

TIME CRISIS®2 & ©1995, 1997, 2001 NAMCO LTD., ALL RIGHTS RESERVED. GUNCON™2 & ©2000 NAMCO LTD., ALL RIGHTS RESERVED. GUNCON™ & ©1996 NAMCO LTD., ALL RIGHTS RESERVED. Manufactured pursuant to license with Namco Holding Corp.

Licensed for play on the PlayStation 2 computer entertainment systems with the NTSC U/C designation only. "PlayStation" and the "PS" Family logo are registered trademarks of Sony Computer Entertainment Inc. The ratings icon is a trademark of the Interactive Digital Software Association. Manufactured and printed in the U.S.A. THIS SOFTWARE IS COMPATIBLE WITH PLAYSTATION 2 CONSOLES WITH THE NTSC U/C DESIGNATION. U.S. AND FOREIGN PATENTS PENDING.

GUNCON™2 is not officially licensed by Sony Computer Entertainment America Inc. (SCEA). SCEA is not responsible for the functionality and operational compatibility of Guncon2. SCEA shall further not be held responsible for any actual, incidental or consequential damages that result from possession, use or malfunction of Guncon2. Please see the product manual for important information about the operation of the product and the warranties that apply.

namco
www.namco.com